

NOTES: UNLESS OTHERWISE SPECIFIED

- 1. MATERIAL-CARBON STEEL
- 2. RATED TO 3000lbs (1361kg) PER PAIR
- 3. 2015.100--PRIME COATED
- 4. 2015.150--UNFINISHED
- 5. 2015.200--GALVANIZED

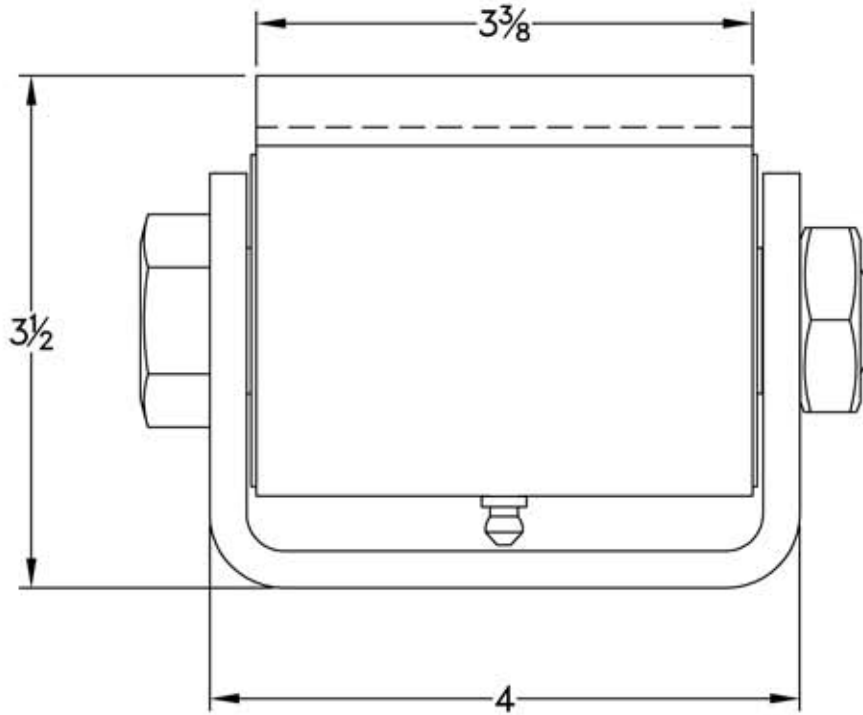

DESCRIPTION				
GUARDIAN HEAVY DUTY HINGE				
DATE	03/14/11	SCALE	AS DIMENSIONED	
DRAWN BY	REJ	SHEET	1 OF 1	
		SHEET SIZE	A	
PART NUMBER	2015.XXX		REVISION	-

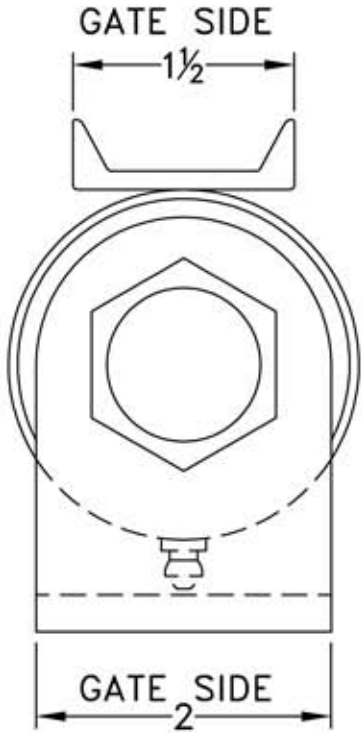