

NOTES: UNLESS OTHERWISE SPECIFIED

- 1. MATERIAL-CARBON STEEL
- 2. RATED TO 1000lbs (454kg) PER PAIR
- 3. 2110.100--PRIME COATED
- 4. 2110.150--UNFINISHED
- 5. 2110.200--GALVANIZED

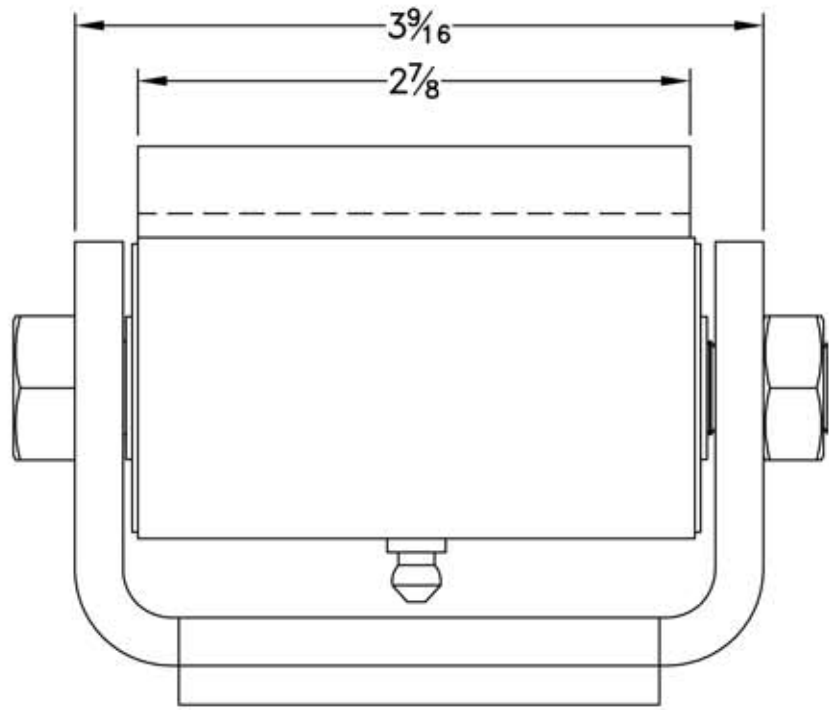

DESCRIPTION			
GUARDIAN STANDARD HINGE			
DATE	03/14/11	SCALE	AS DIMENSIONED
DRAWN BY	REJ	SHEET	1 OF 1
		SHEET SIZE	A
PART NUMBER			REVISION
2110.XXX			-

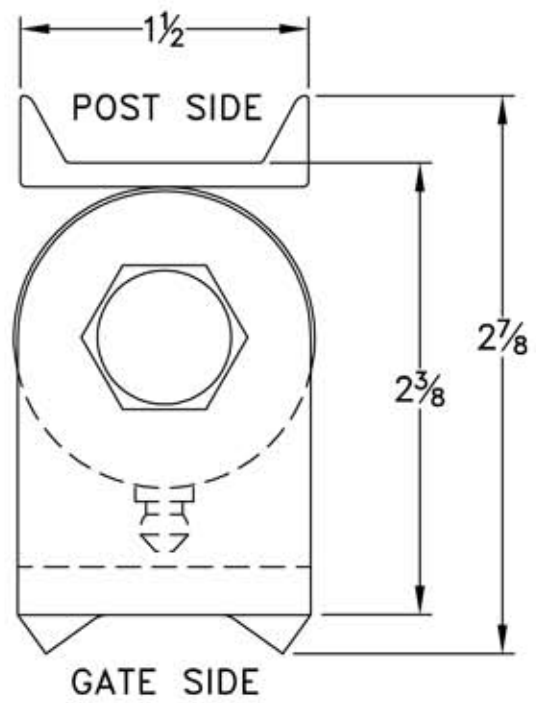